

HRANEC Ductwork Catalog

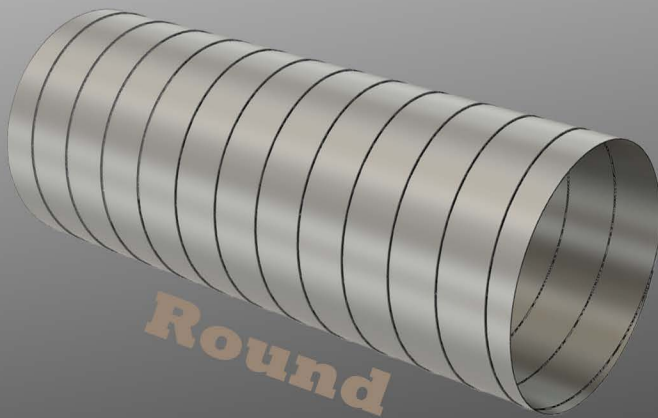

**Over 30 Years of
Manufacturing
Experience**



Round

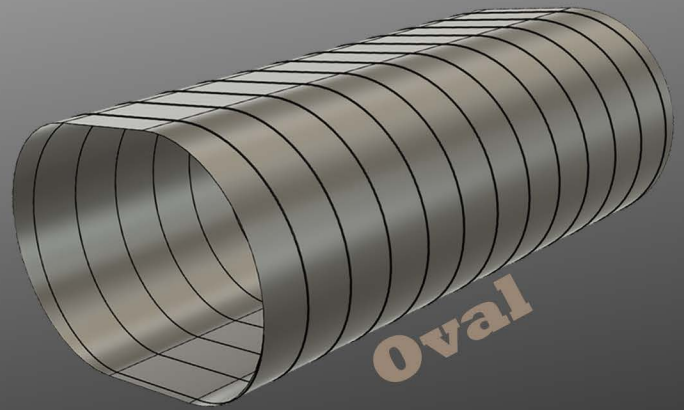

Oval



Rectangular



Complete Line of Manufactured Accessories



Hranec Corporation's Central Offices and Manufacturing Facilities Company Milestones

Hranec Corporation's Central Offices and Manufacturing Facilities are located in Uniontown, Pennsylvania (just south of Pittsburgh).

In the Early 2000's Owner and Founder Steven Hranec geared the company towards Mechanical Contracting work. In a short amount of time Hranec Corp. developed itself into one of the top tier mechanical contractors in the tri state area. As we continue to perform a wide range of projects, rest assured we have the experience needed for projects that require installation of very complex mechanical systems.

2008, Hranec Corporation erected a state of the art fabrication facility, which paved the way for the company's recognition as one of the top notch ductwork manufacturing facilities. Hranec Corp. fabricates quality ductwork not only for its own construction projects but for supply houses and contractors located throughout the United States and Canada and is now recognized as a leader in the ductwork manufacturing market. Hranec Corp always values safety as Pennsylvania's top 10 safest places to work in its field with a MOD rating below 0.7 since 2017.

2015, Hranec Corporation branched out into the HVAC Service market providing 24-hour HVAC emergency service and preventive maintenance work. In addition, the company also added a certified NADCA ductwork cleaning department.

2021, brought the opening of a 40,000 square-foot roof curb and equipment rail fabrication shop. The design of the shop enables the fastest lead times in the industry for roof curb and equipment rail manufacturing. In addition to the roof products line Hranec Corp. has also incorporated pipe portals, mighty mount roof systems options and pre-fabricated structural roof supports for pipe and ductwork.

2023, Hranec Corporation Introduced Tuff Duct Systems, (Patent Pending), which is the ultimate outdoor ductwork built to with-stand extreme weather conditions. Tuff Duct captures everything Engineers, Architects, Building Owners and Contractors absolutely desire for outdoor ductwork applications.

2023, Hranec Corporation Introduced Dust Duct. Dust Duct offers ductwork selections for Collection Systems, from flanged clamp together systems all the way to Van Stoned Angle Ring connection systems. Dust Duct also leads the way introducing the very first spiral ductwork system incorporating a clamp together non-penetrating connection.

2024, Future plans include development of an 26-acre site, constructing 200,000 square ft. building of additional manufacturing space.



What You Can Expect with Hranec

Quotes =

Quick Turn Around Time.
Accurate Take Offs
Send Quotes To: quotes@hranec.com

Fabrication =

We Get Your Orders Out Fast.
With Our State-of-the-art Fabrication Facility

Delivery =

On Time as Requested.
With Our Own Fleet of Trucks

- Customer Service
- Union Made
- Manufactured in the USA
- Plans & Specs Quoting Service
- Unmatched Lead Time
- Full Service Quote to Delivery



Spiral Pipe

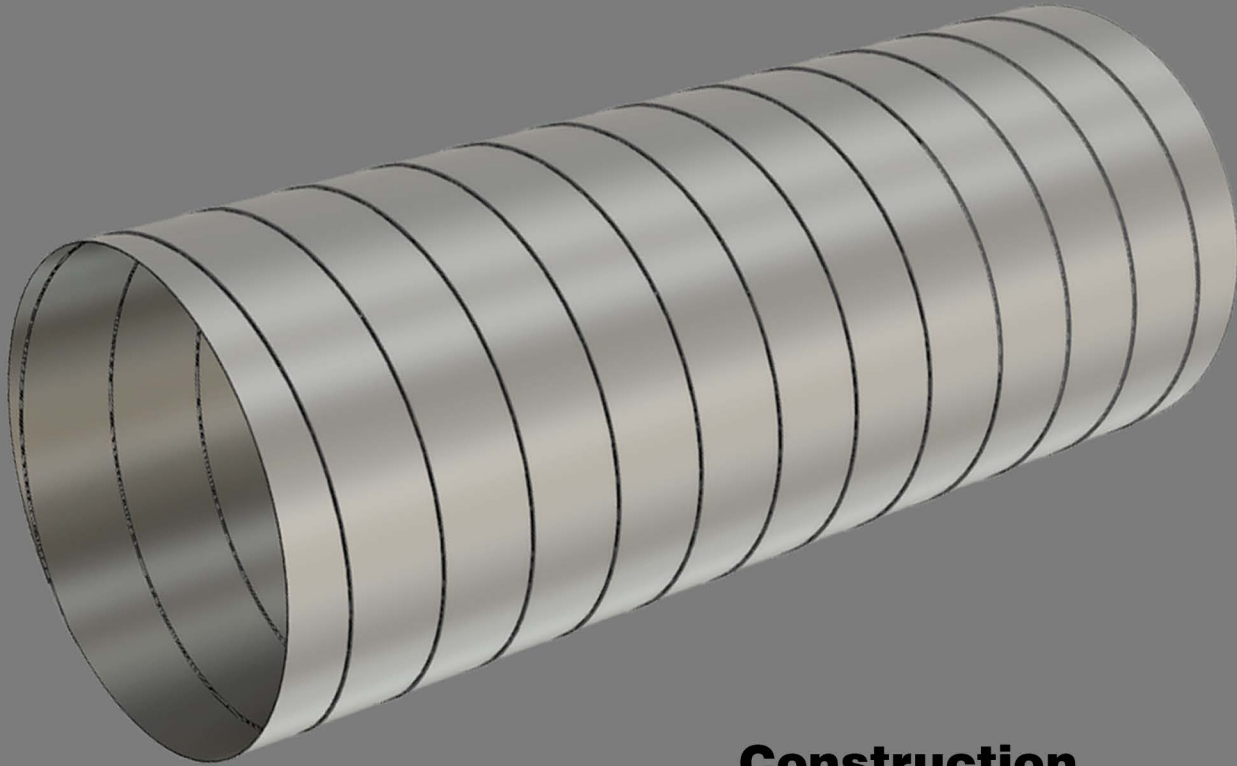

Available Sizes

Even Diameters 4" to 96"

Odd Diameters 5" to 9"

Materials

Galvanized, Paint Grip,
Aluminum, Stainless Steel, PVC

Construction

Single Wall Construction

Single Wall Liner Available

Double Wall is Available in
1", 2" and 3" Fiberglass,
fully Insulated.

Connections: Slip Fit, Gasketed,
Hranaflange, Angle Ring.

Gauges 16 Through 26

Stock: 10' Lengths



Fittings

Couplings



Non-Gasketed Slip Fit Sizes 4" and Up
Gasketed Gasketed Sizes 5" and Up

Saddle-Tap



Non-Gasketed Slip Fit Sizes 4" and Up
Gasketed Gasketed Sizes 5" and Up

End Cap



Non-Gasketed Slip Fit Sizes 4" and Up
Gasketed Gasketed Sizes 5" and Up

90 Degree Elbow



Non-Gasketed

Non-Gasketed Sizes: 4" and Up

Gasketed

Gasketed Sizes: 5" and Up

45 Degree Elbow

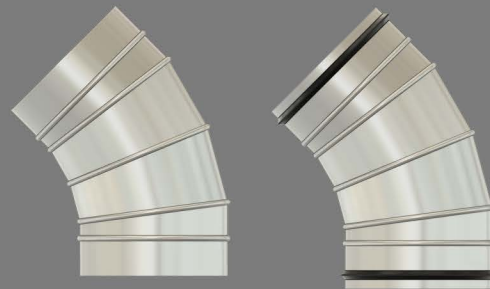

Non-Gasketed

Non-Gasketed Sizes: 4" and Up

Gasketed

Gore Lock Seam

Gasketed Sizes: 5" and Up

Tee

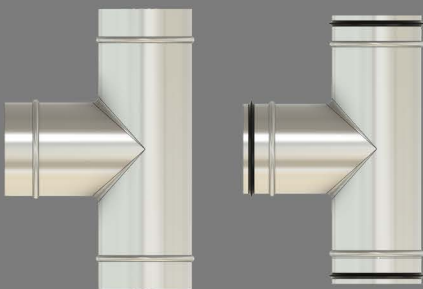

Non-Gasketed

Non-Gasketed Sizes: 4" and Up

Gasketed

Gasketed Sizes: 5" and Up

Gasket

Double Lipped EPDM Rubber
Fast and Easy Installation
Can be Installed in All Kinds of Weather
Environmentally Friendly - Solvent Free

Reducer



Non-Gasketed

Non-Gasketed Sizes: 4" and Up

Gasketed

Gasketed Sizes: 5" and Up



Stick-On Fittings

Sizes Available on all Taps: 4" and Up

Straight Stick-On no Damper

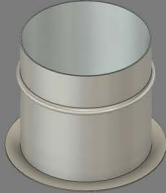

STO Sticky no Damper

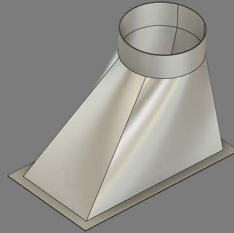

Conical Stick-On no Damper



Straight Stick-On W/ Damper



STO Sticky W/ Damper



Conical Stick-On W/ Damper



Straight Stick-On W/ Damper & Rapid Stand-off

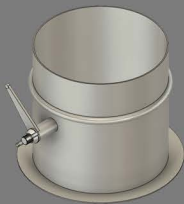

STO Sticky W/ Damper & Rapid Stand-off



Conical Stick-On W/ Damper & Rapid Stand-Off



Straight Sticky W/ Damper & Bracket Stand-off w 3/8" Continuous Rod

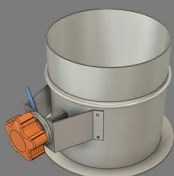

STO Sticky W/ Damper & Bracket Stand-off w 3/8" Continuous Rod

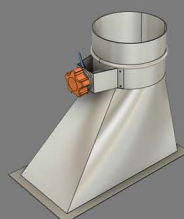

Conical Stick-On W/ Damper & High Hat Stand-off w 3/8" Continuous Rod

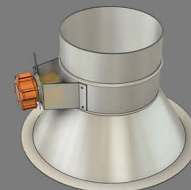



Connections

Hrana Flange

Round



Oval



16 Gauge

Sizes 8" to 96" Available (1" increments)

Materials

Galvanized, Aluminum, Stainless Steel, PVC

Angle Rings

Round

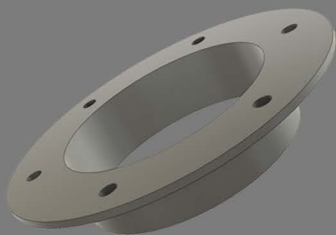

Oval



Sizes 3" and Up



Oval Pipe

Spiral Oval

Minor Sizes Available: Even Sizes 6" through 22"

Major Sizes Available: All Sizes 18" through 97"

One Seam Oval Pipe

Available in All Sizes

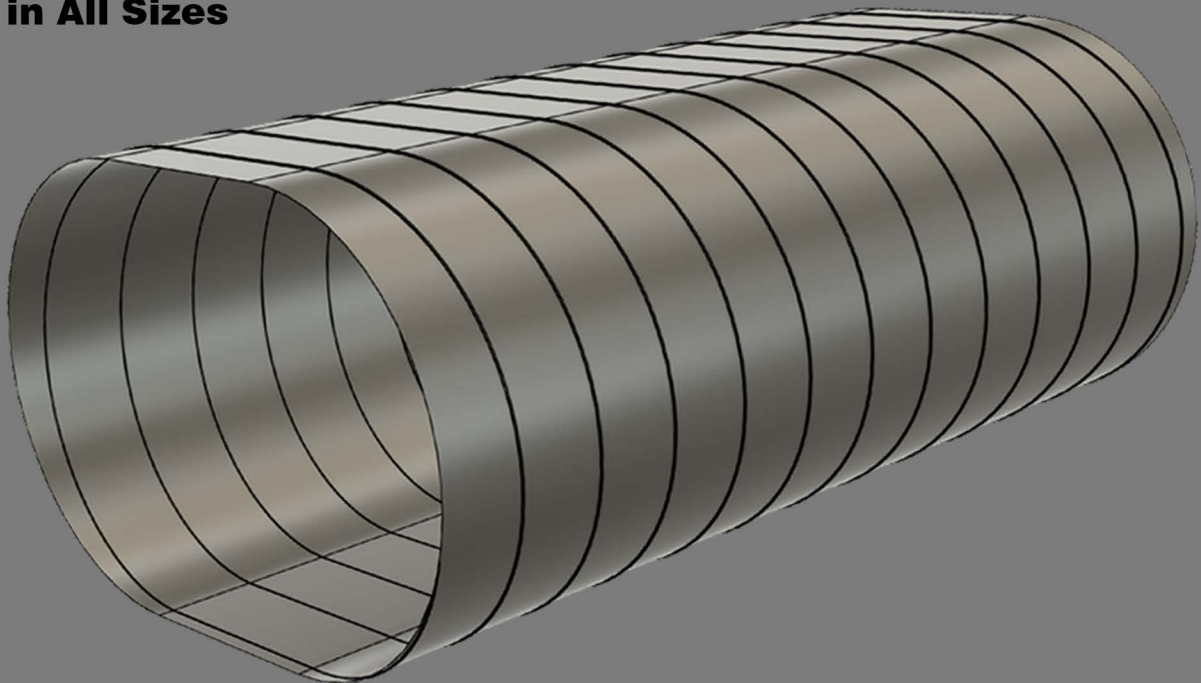

Materials

**Galvanized, Paint Grip,
Aluminum, Stainless Steel,
PVC**

Construction

Gauges: 16 Through 22

**Connections: Slip Fit, Flanged or
Angle Ring**

**Single Wall, Double Wall and
Lined Duct Available**

**Double Wall and Lined Duct are
available in 1" and 2" Fully Insulated.**



Oval Fittings

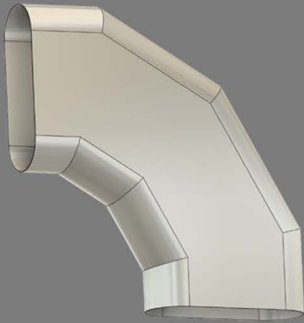

Hard Bend 90 Elbow

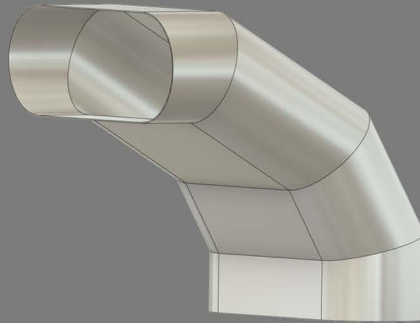

Easy Bend 90 Elbow

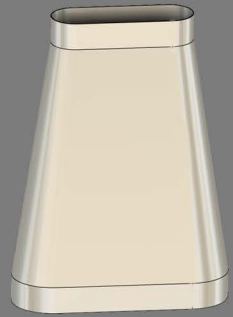

Reducer

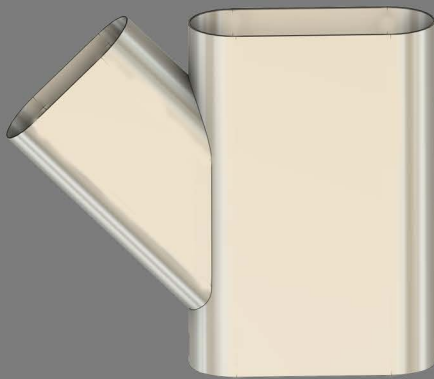

Lateral Tee

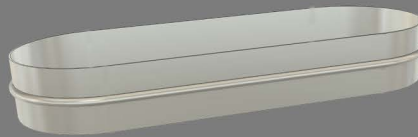

Coupling



Conical Tee



Offset



Oval to Round



One Seam Pipe



Manifold Taps

Register Taps

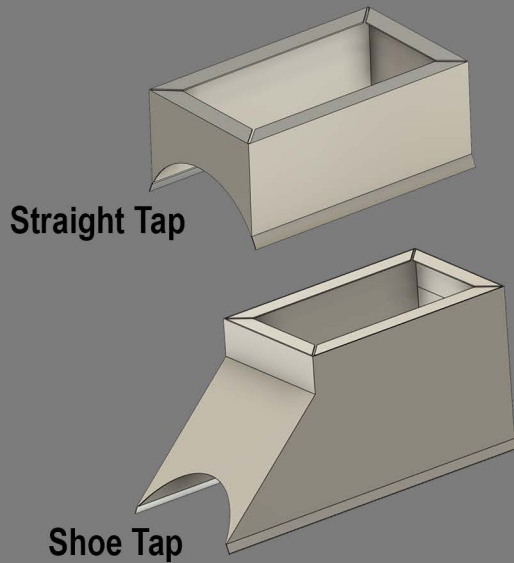

Full Body Fittings



Spiral or Oval Installed Taps

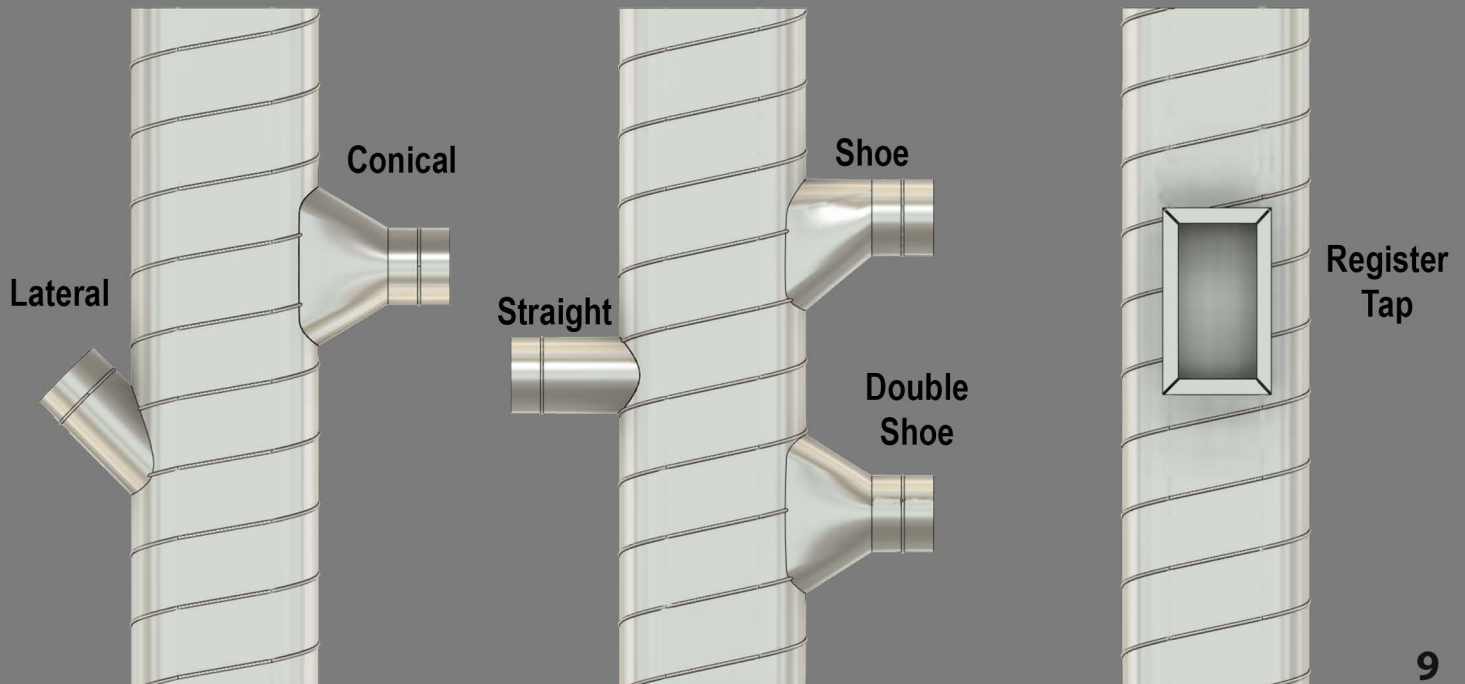



Rectangular

Hranec takes great pride in the quality and standards of their rectangular ductwork! Ensuring that our products exceed SMACNA construction standards and meet rigorous quality control guidelines. This is crucial for maintaining high performance and compliance with state and federal requirements.

Hranec is dedicated to excellence in the HVAC industry! Leveraging the latest equipment and strategic processes to produce high-quality ductwork and HVAC materials is key to meeting the needs of commercial and light industrial projects. Our focus on customer service and ensuring comfort and quality in every project truly sets Hranec apart.

Lengths

Slip and Drive = 59"

TDC = 56"

Ductmate Flange = 60"

Construction

Gauges 16 Through 26

Insulation: Black Matt Face and Armaflex

Connections: Slip and Drive, TDC or Ductmate Flange

Materials

Aluminum, Stainless Steel, PVC, Galvanized, Paint Grip, Perforated

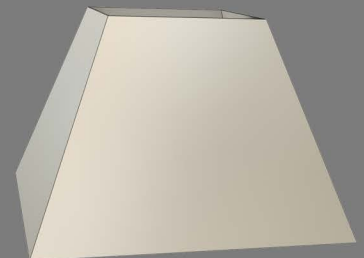
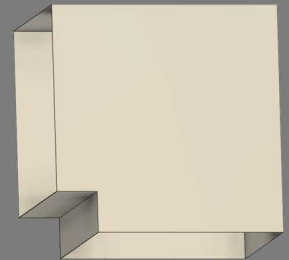
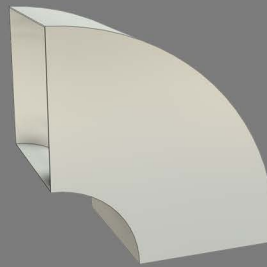



Paint Coatings

For applications that require ductwork to be painted to complement the surrounding architecture.

Custom Paint Colors



Ductwork can be painted to any custom color.

Available Sizes
Even Diameters 4" to 70"
Odd Diameters 5" to 9"

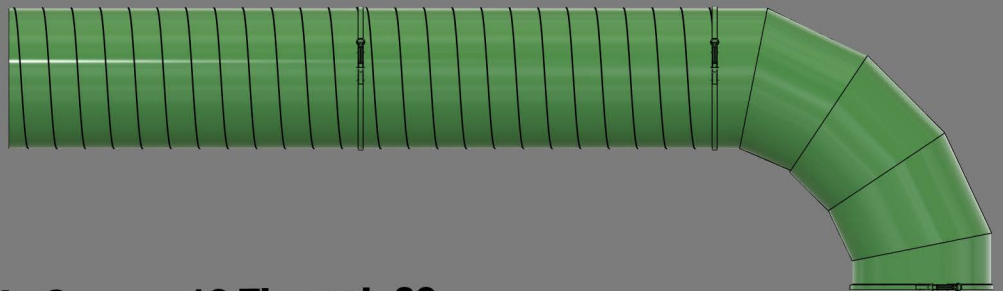

Base Metal: Paint Grip in Gauges 16 Through 26

Connections: Slip Fit, Gasketed, Hranaflange, Angle Ring Painted to match.





Spiral Graphix

Brand New for 2025 Breathtaking Exposed Spiral Graphix



Replace your standard painted spiral ductwork with factory applied fully customizable graphix, showcasing your exposed spiral ductwork like never before. Spiral Graphix utilizes patented cutting and adhesion technology.



Please call us at 724-880-9659 or email josh@spiralgraphix.com to inquire about your next exposed spiral ductwork project.



CAD Drawings

CAD Drawing Features

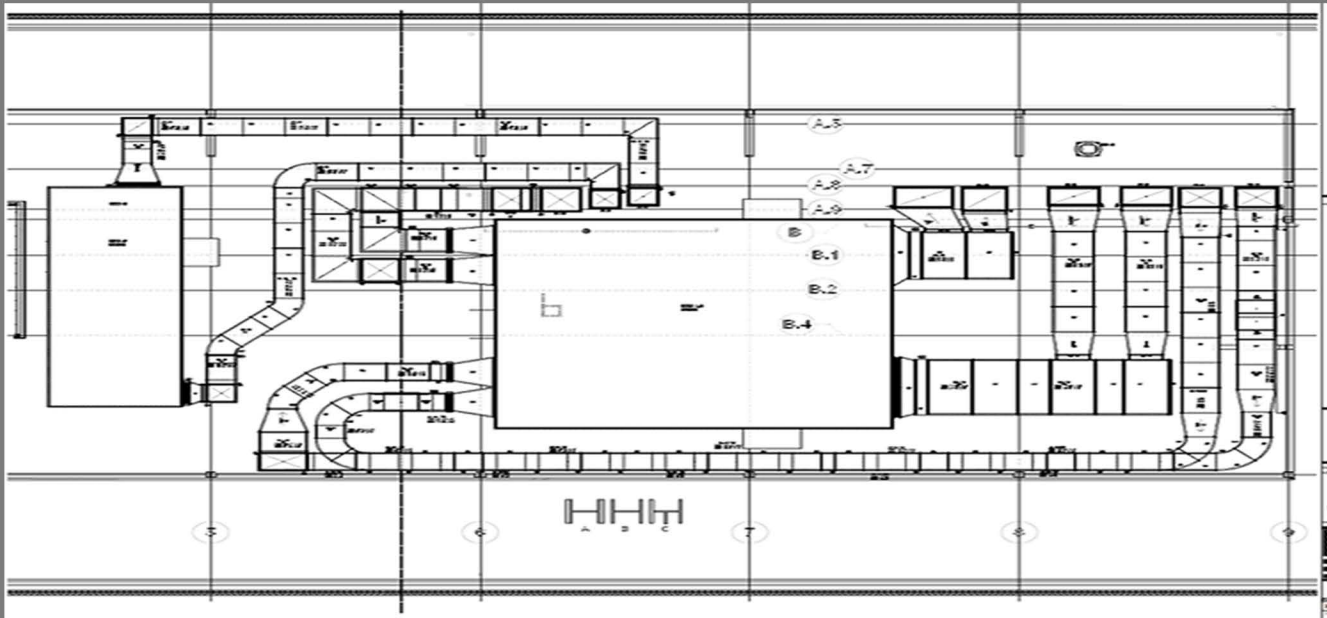

- Upon PO CAD coordination drawings are produced within 5 days
- All orders will come with CAD Drawings with pieces tagged and numbered which will match each piece of ductwork to make installation very easy
- All supports will be calculated and spaced on our CAD Drawings
- Pre assembly sections can be ordered and shown as spool pieces on our CAD Dwgs.
- Lifting lugs can be placed on CAD Drawings for assembled sections
- Cross over stairways can be added per request



Delivery

Shipping Ductwork



Freight Included Across the USA and Canada

Field measured pieces will ship within 5 days of field releasing based on typical standard sheet metal practices

Quick ships are available

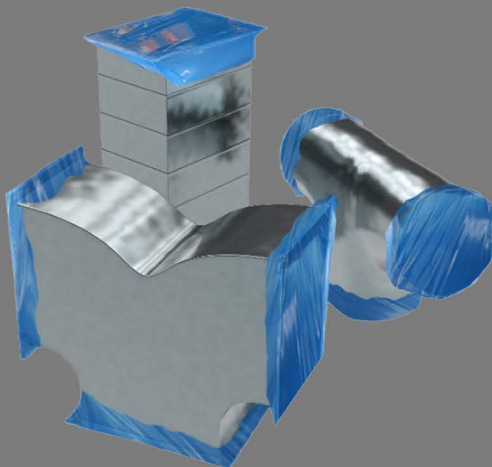

All Ductwork ends will be covered with sticky removable plastic to keep dirt and dust out of ductwork until time for installation

HRANEC

Manufacturing Dept.



Other Products Available

USA
TUFF DUCT
SYSTEMS
tuffductsystems.com

Your #1 Leader in
Outdoor Ductwork Products

Maximum
5 Year Weather
Warranty

Saves Weather
Resistance Cost
Outer Shell

Leak Proof
TUFF CAP
Detachable Core

UNION MADE
MADE IN
USA

Standard
Ductwork Install
Practices

ENERGY
EFFICIENT

HVAC System
Guaranteed for
25 Years
Approved

SMACNA

A PRODUCT MANUFACTURED BY HRANEC CORP. 724-437-2211 info@hranec.com

USA
DUST DUCT
Dust Collection Duct System
dustductsystems.com

Submittal Information Guide

Contact Info: Dave Procratsky
Phone #: 724-880-2022 Email: dave@hranec.com

HRANEC CORP.
Roof Products

CURBS AND EQUIPMENT RAILS

PIPE PORTAL SYSTEMS

NON-PENETRATING ROOF SUPPORTS

MFG
Ductwork
Page